

SIDE VIEW

187.3 (+/- 5,5mm.)

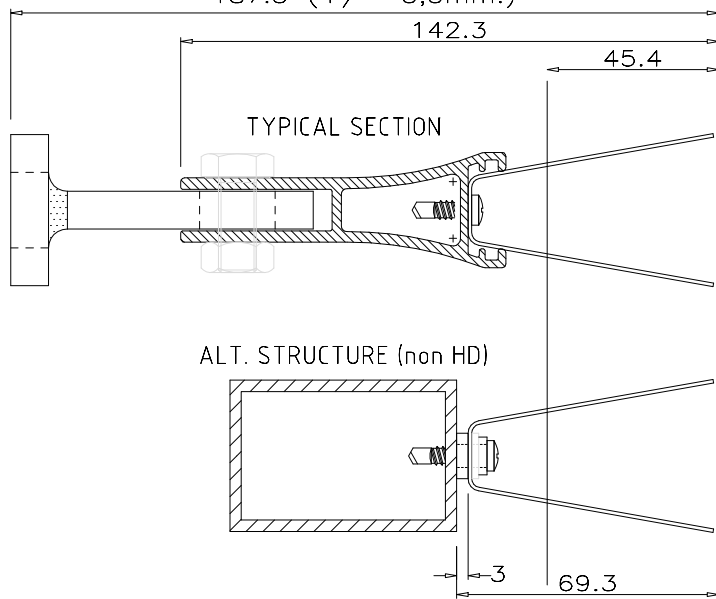

TYPICAL SECTION

ALT. STRUCTURE (non HD)

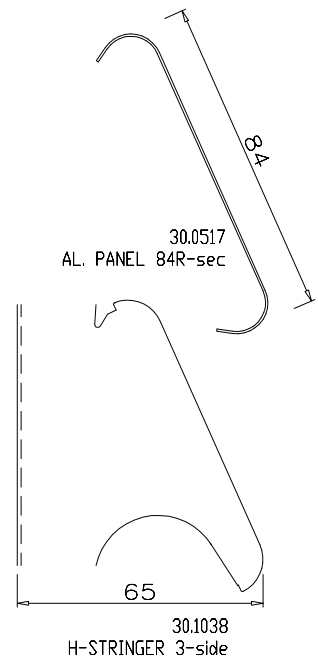

30.0517
AL. PANEL 84R-sec

30.1038
H-STRINGER 3-side

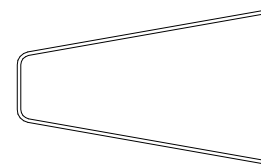

30.1038
H-STRINGER 3-sec



30.4133
WASHER SET-front

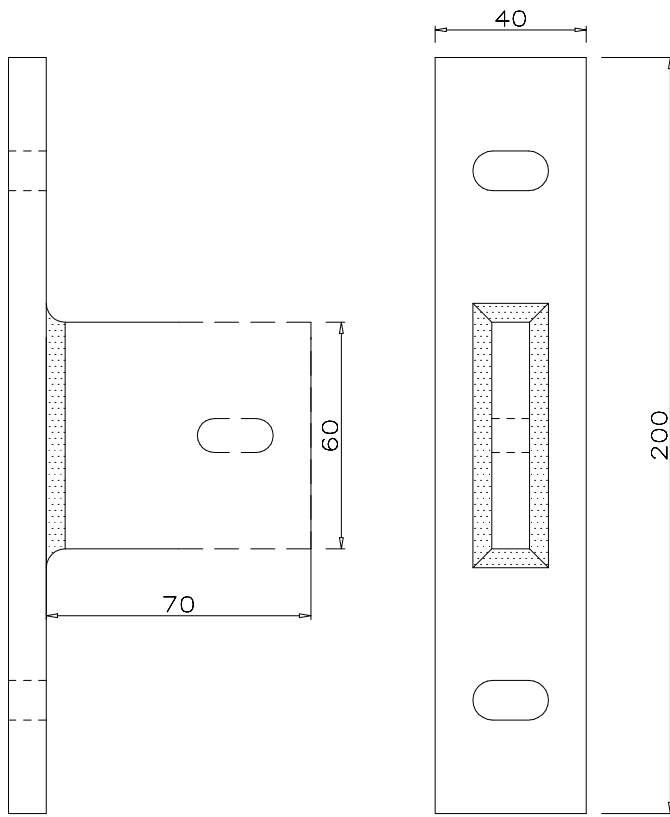

ACC. WALL BRACKET
FOR SLR 60V-side

ACC. WALL BRACKET
FOR SLR 60V&H-front

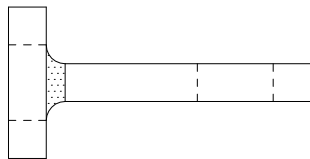

ACC. WALL BRACKET
FOR SLR 60V-top

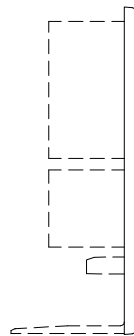

30.5060 SLR 60
END CAP M-side

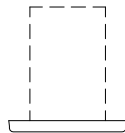

30.5060 SLR 60
END CAP M-top

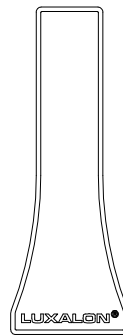

30.5060 SLR 60
END CAP M-front

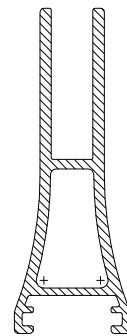

30.4604 SLR
60V-sec

