

* -

HunterDouglas 
Architectural

Drwg.No. C-i-Me-PI-Alpha -Bandraster -2D_Application A	Date: 19.07.2019	Scale: 1:5
	Size: A3	Rev: -
Subject: Ceiling Interior Metal Planks Alpha Bandraster		

**Plank Alpha
bandraster 50 Al / Fe**

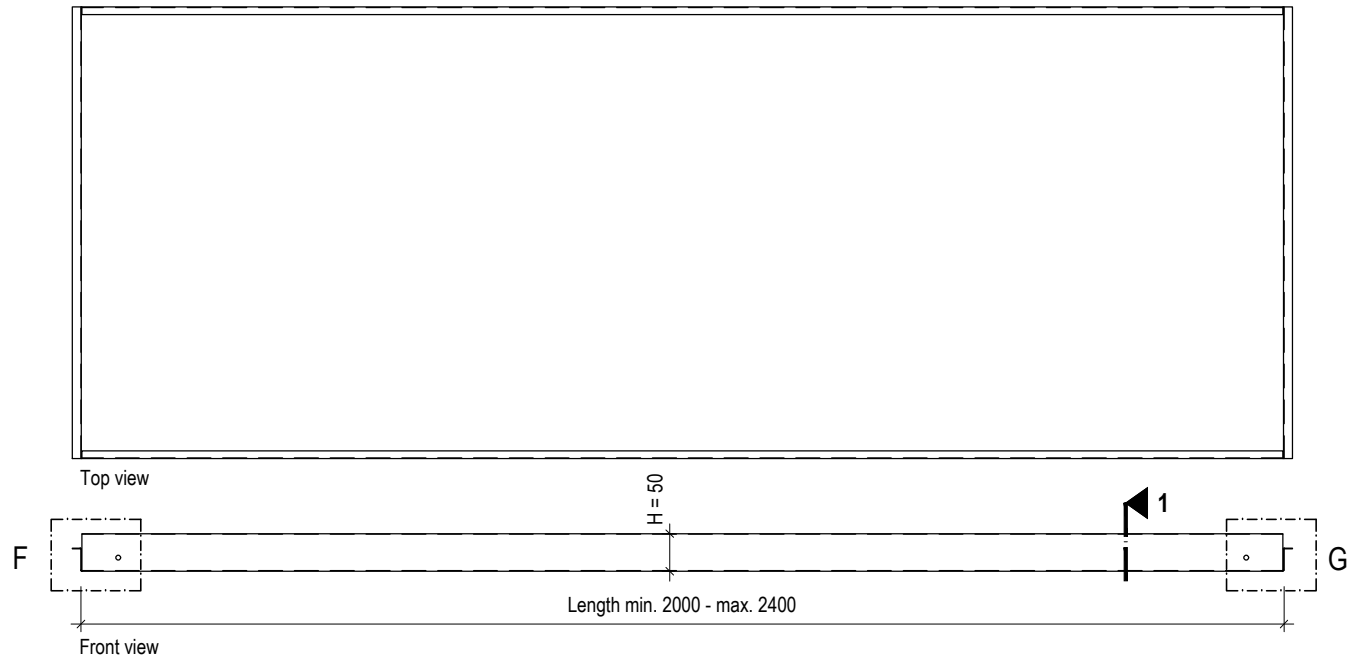
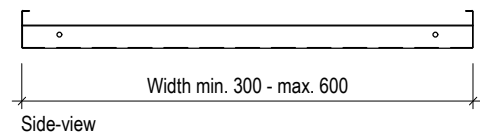

**Plank Alpha
bandraster 40 Al / Fe**

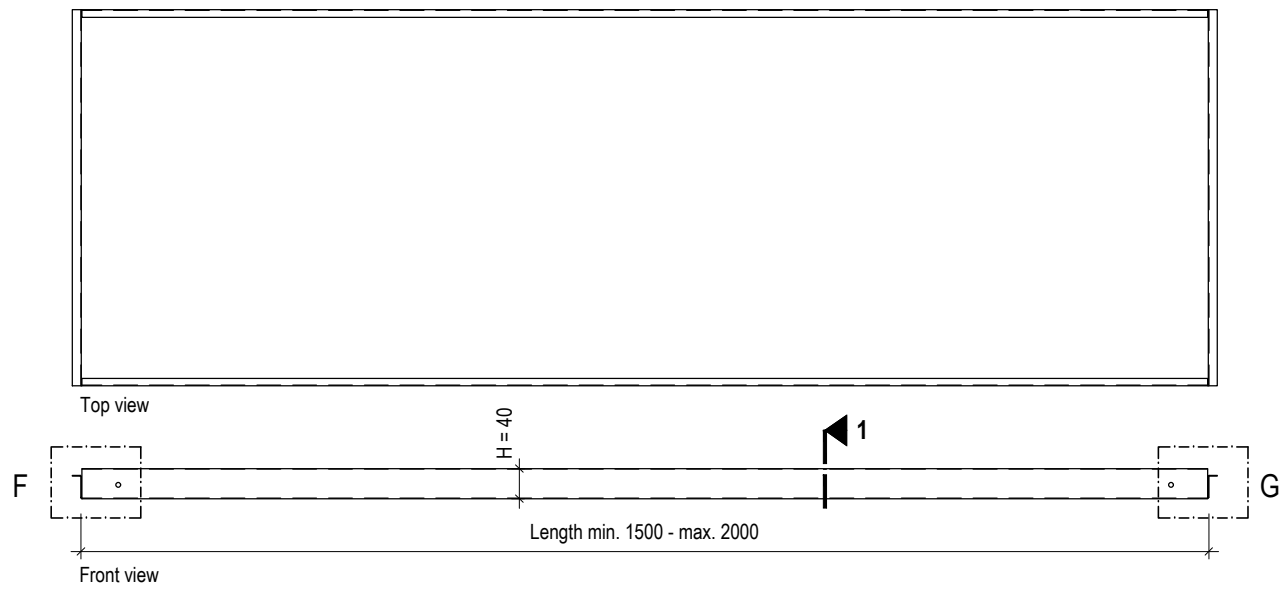
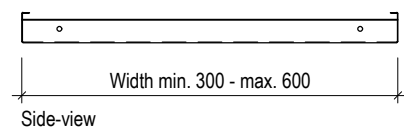

**Plank Alpha
bandraster 30 Al / Fe**

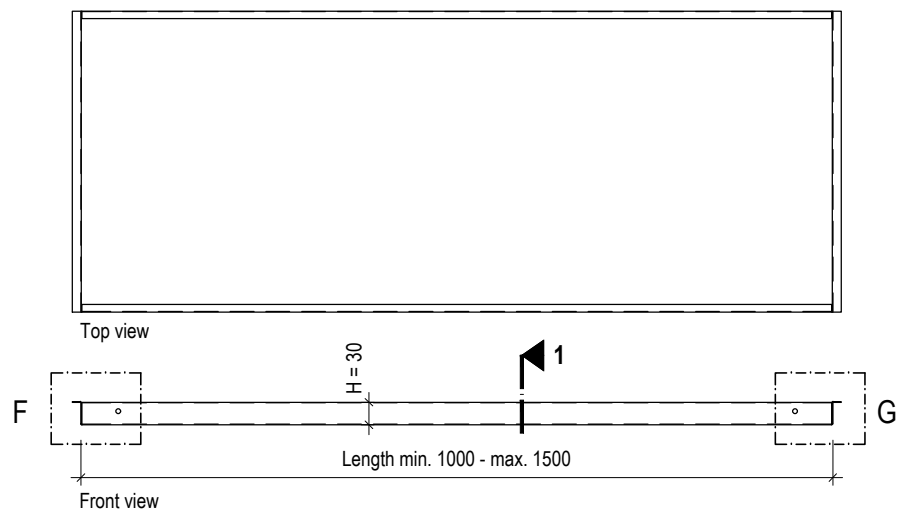
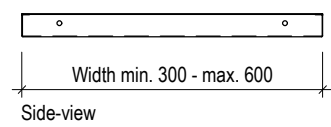

PERFORATION PATTERNS scale 1:1

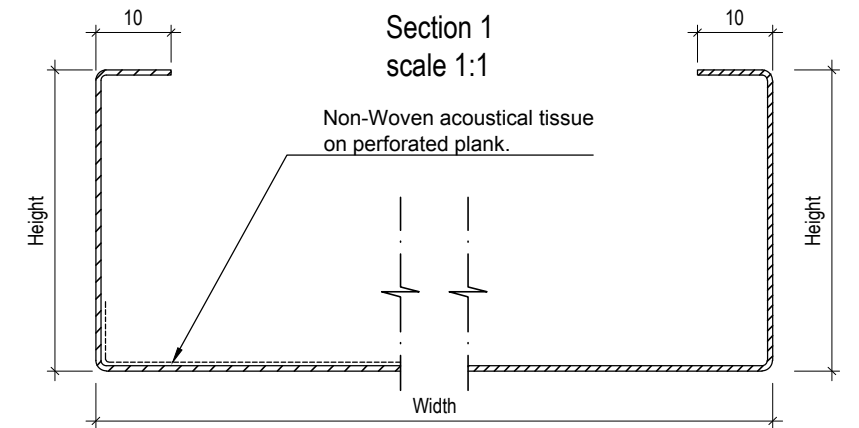
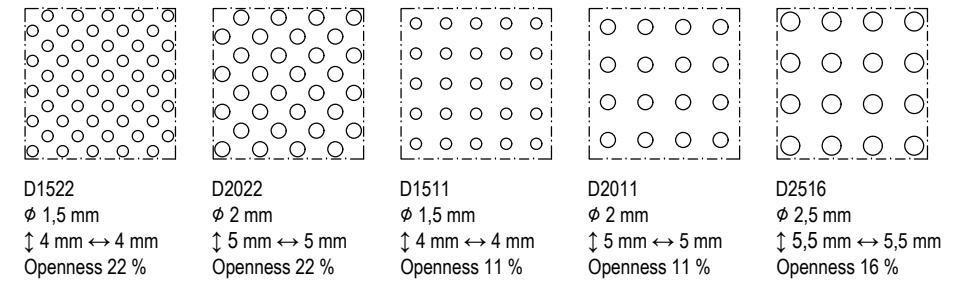

Width from	to	Length from	to	Height
300	600	1000	1500	30
300	600	1500	2000	40
300	600	2000	2400	50

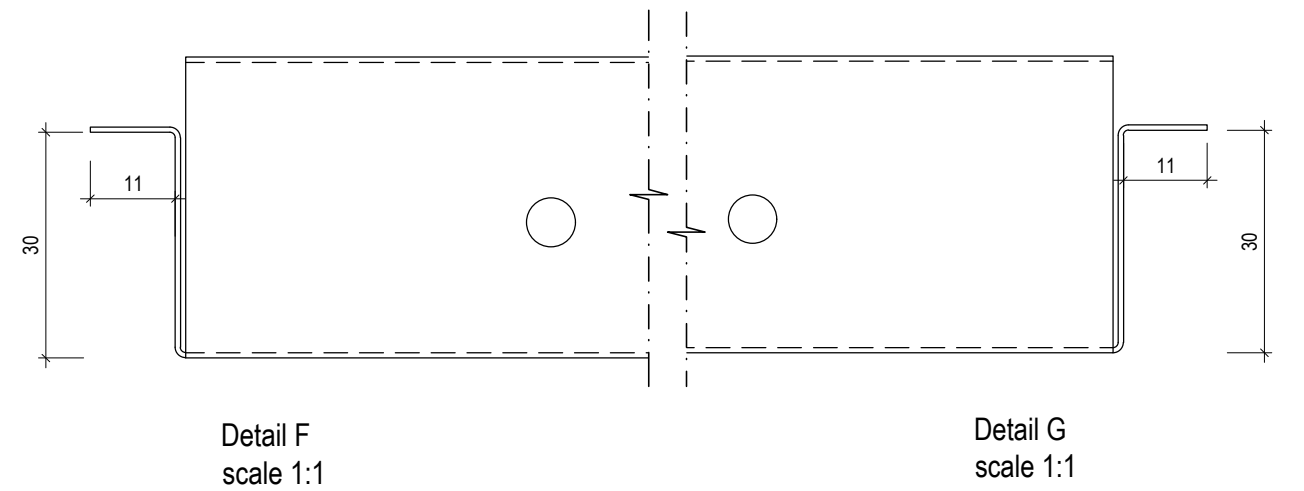

ALPHA BANDRASTER type 1

Al / Fe

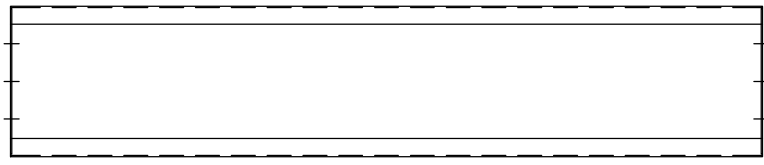

Top view

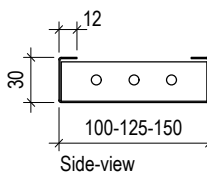

Side-view

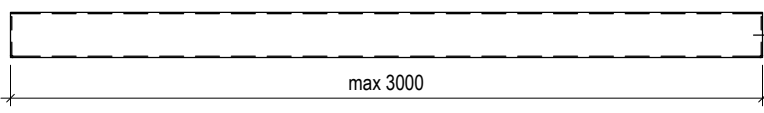

Front view

max 3000

ALPHA BANDRASTER type 2

Al / Fe



Top view

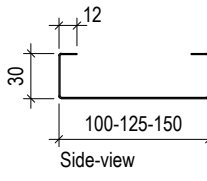

Side-view

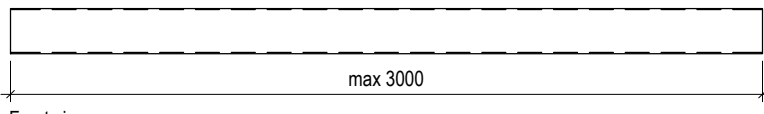

Front view

max 3000

U PROFILE ALPHA

Fe

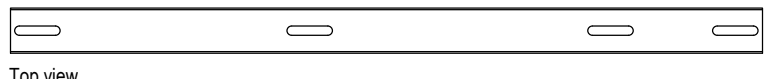

Top view

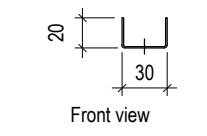

Front view

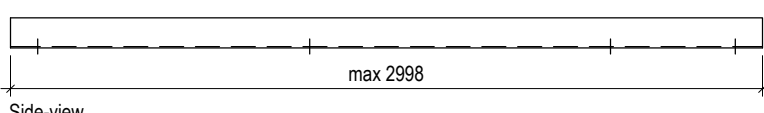

Side-view

max 2998

BRACKET ALPHA 100 Fe

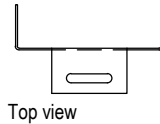

Top view

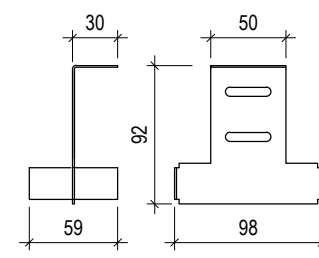

Front view Side-view parallel

BRACKET ALPHA 125 Fe

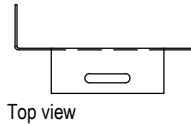

Top view

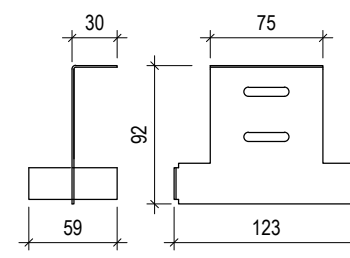

Front view Side-view parallel

ALPHA BANDRASTER SPLICE

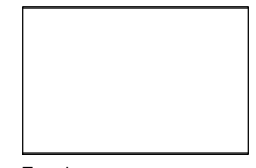

Top view

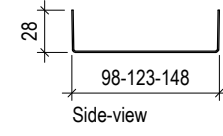

Side-view

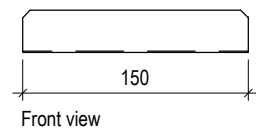

Front view

SPACER 3 mm

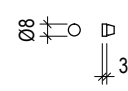

BRACKET ALPHA 150 Fe

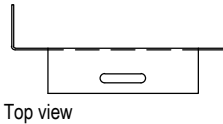

Top view

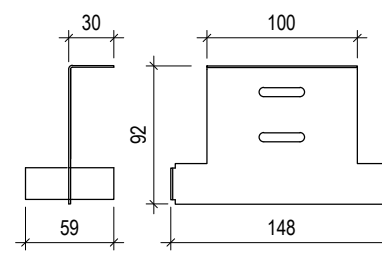

Front view Side-view parallel

UPPER NONIUS HANGER

Length: 150, 300, 500, 1000, 1500, 2000mm

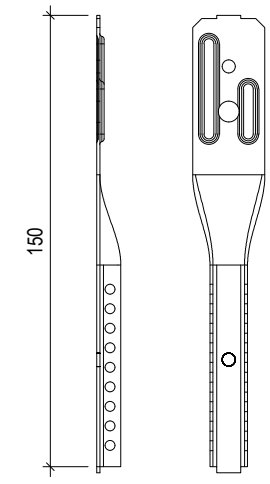

Side view Front view

LOWER NONIUS HANGER

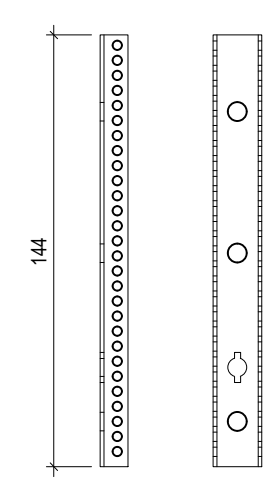

Side view Front view

EDGE-PROFILE Al / Fe

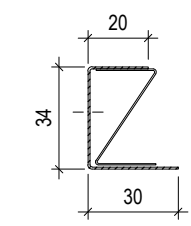

EDGE-PROFILE U 30 L= max.3000 mm

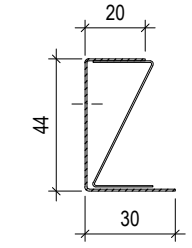

EDGE-PROFILE U 40 L= max.3000 mm

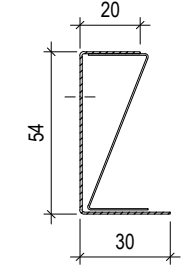

EDGE-PROFILE U 50 L= max.3000 mm

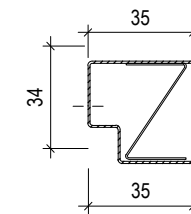

EDGE-PROFILE UW 30 L= max.3000 mm

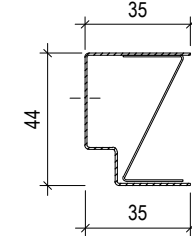

EDGE-PROFILE UW 40 L= max.3000 mm

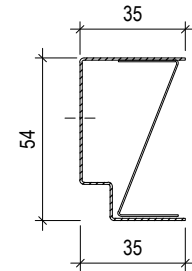

EDGE-PROFILE UW 50 L= max.3000 mm

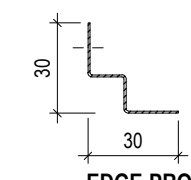

EDGE-PROFILE W 30 L= max.3000 mm

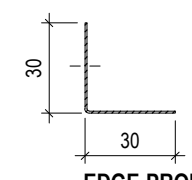

EDGE-PROFILE L 30 L= max.3000 mm

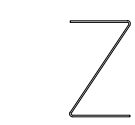

LOCKING-PROFILE 30 L= max.1160 mm



LOCKING-PROFILE 40 L= max.1160 mm



LOCKING-PROFILE 50 L= max.1160 mm