

* -

HunterDouglas 
Architectural

| | | |
|---|--------------------|---------------|
| Drwg.No. C-i-Me-PI-Beta -Hook on Safety loop -2D_Application A | Date: 30-3-2020 | Scale: 1:5 |
| | Size: A3 | Rev: - |
| Subject: Ceiling Interior Metal Planks Beta Hook on Safety loop | | |

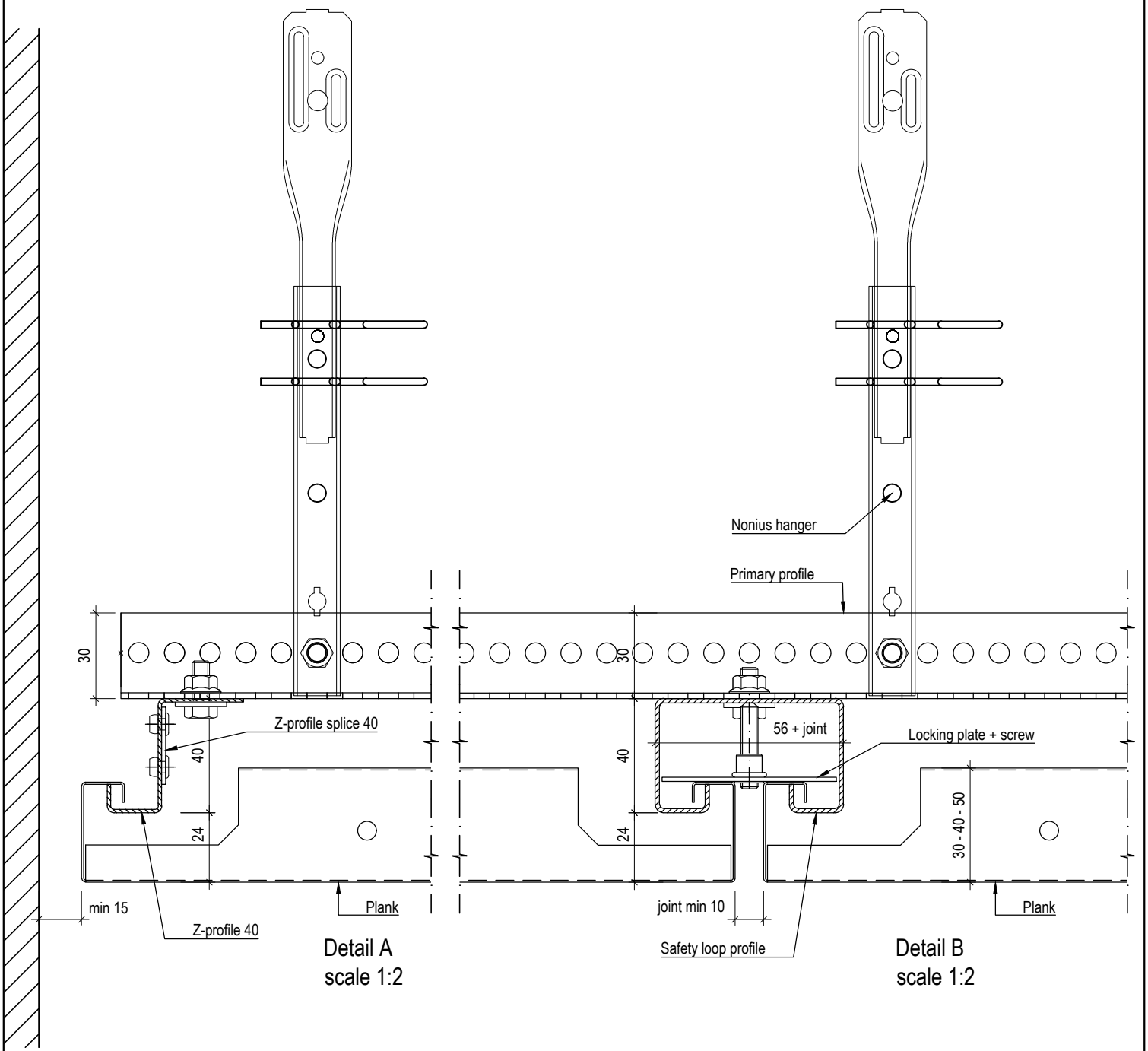

Detail A
scale 1:2

Detail B
scale 1:2

| | | |
|---|--------------------|---------------|
| Drwg.No. C-i-Me-PI-Beta -Hook on Safety loop -2D_Section safety loop | Date: 30-3-2020 | Scale: 1:2 |
| | Size: A3 | Rev: - |
| Subject: Ceiling Interior Metal Planks Beta Hook on Safety loop | | |

**Plank Beta Hook-on Safety loop
Height 50 mm Al / Fe**

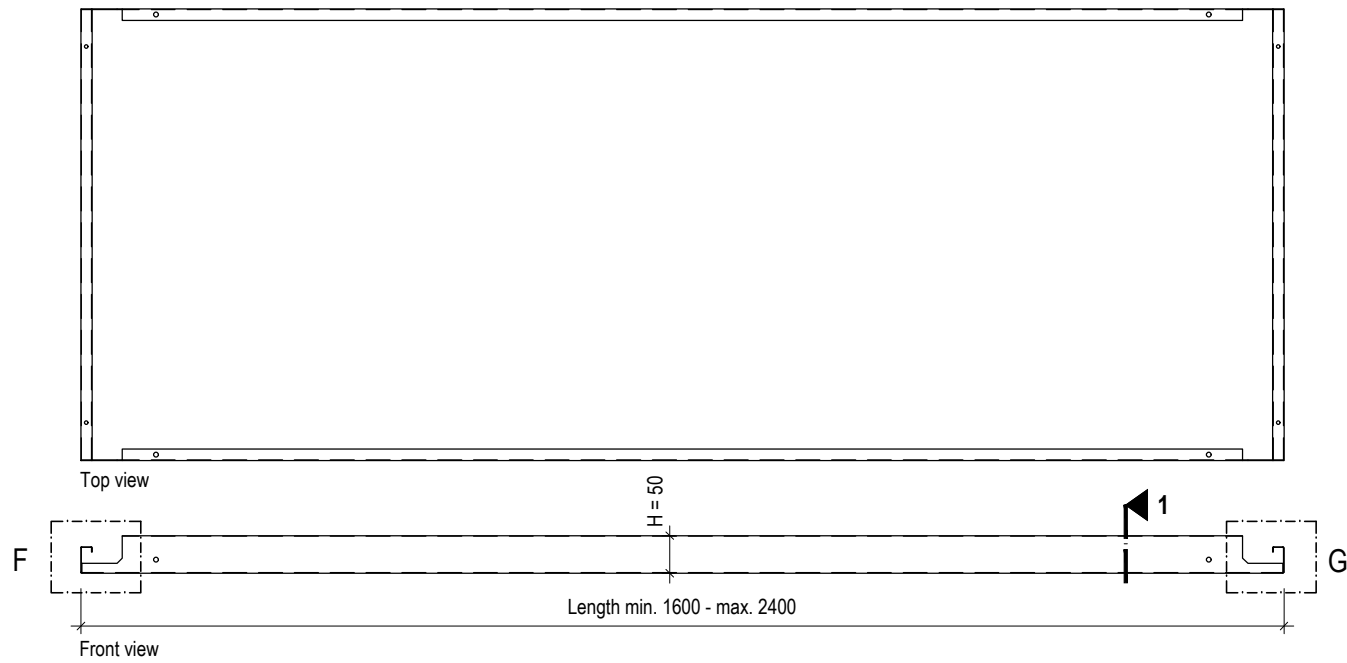
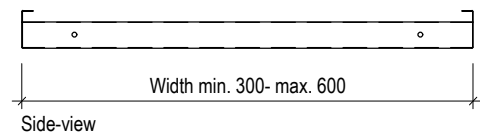

**Plank Beta Hook-on Safety loop
Height 40 mm Al / Fe**

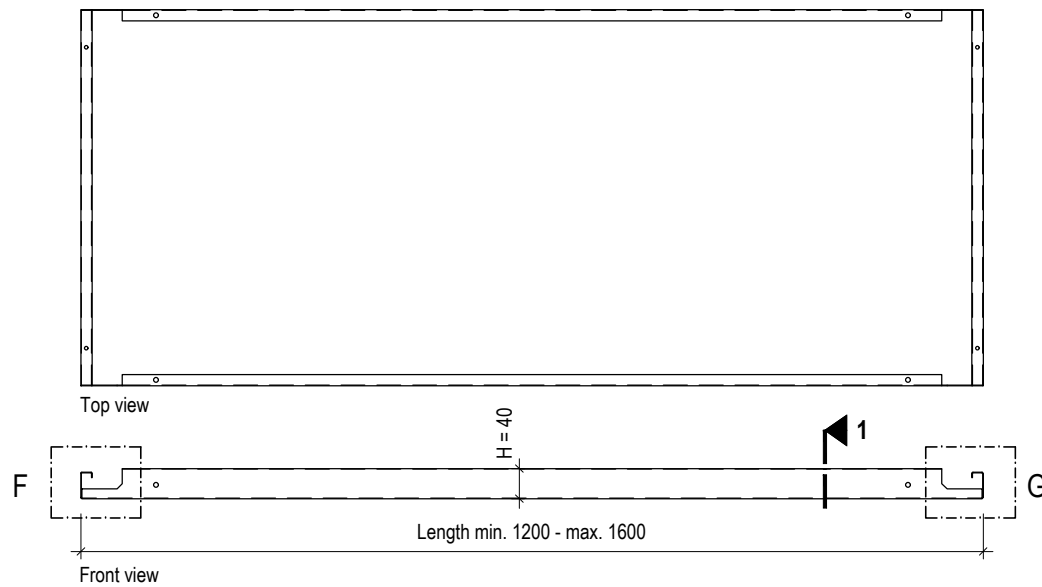
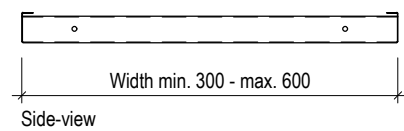

**Plank Beta Hook-on Safety loop
Height 30 mm Al / Fe**

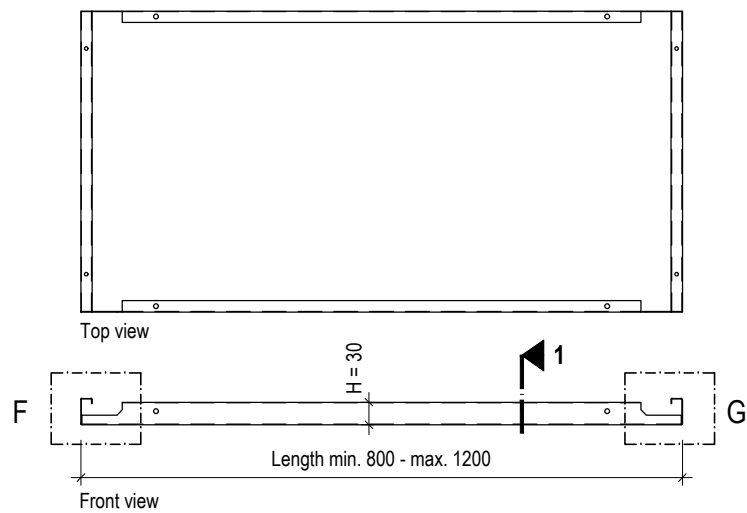
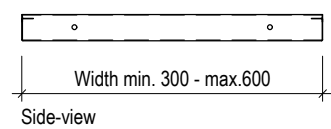

PERFORATION PATTERNS scale 1:1

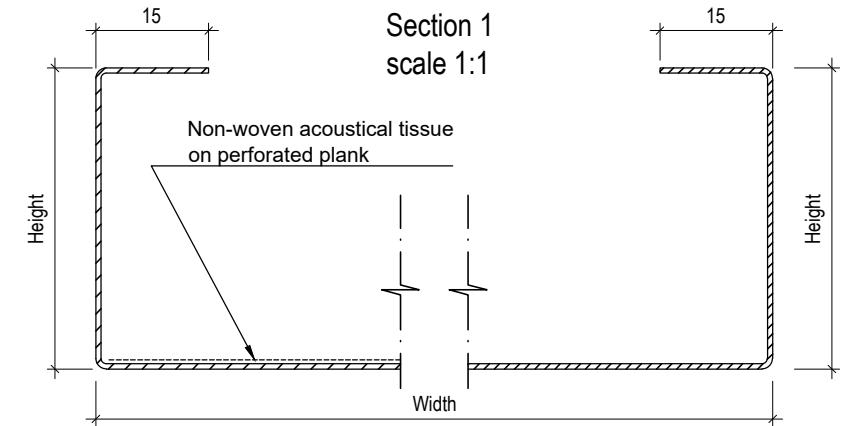
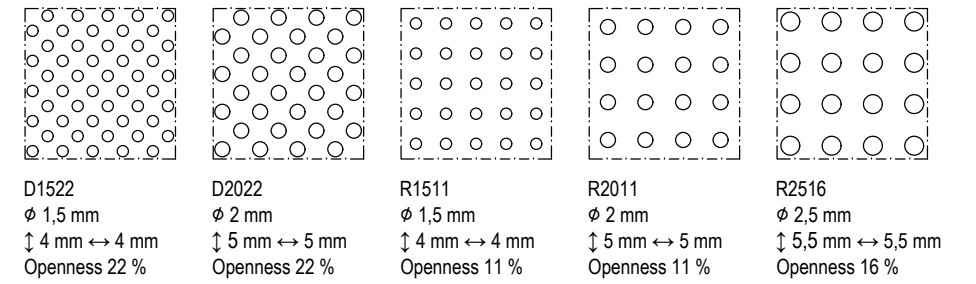

| Width from | Width to | Length from | Length to | Height |
|------------|----------|-------------|-----------|--------|
| 300 | 600 | 800 | 1200 | 30 |
| 300 | 600 | 1200 | 1600 | 40 |
| 300 | 600 | 1600 | 2400 | 50 |
| 600 | 1000 | 800 | 2000 | 50 |
| 300 | 500 | 800 | 3000 | 50 |

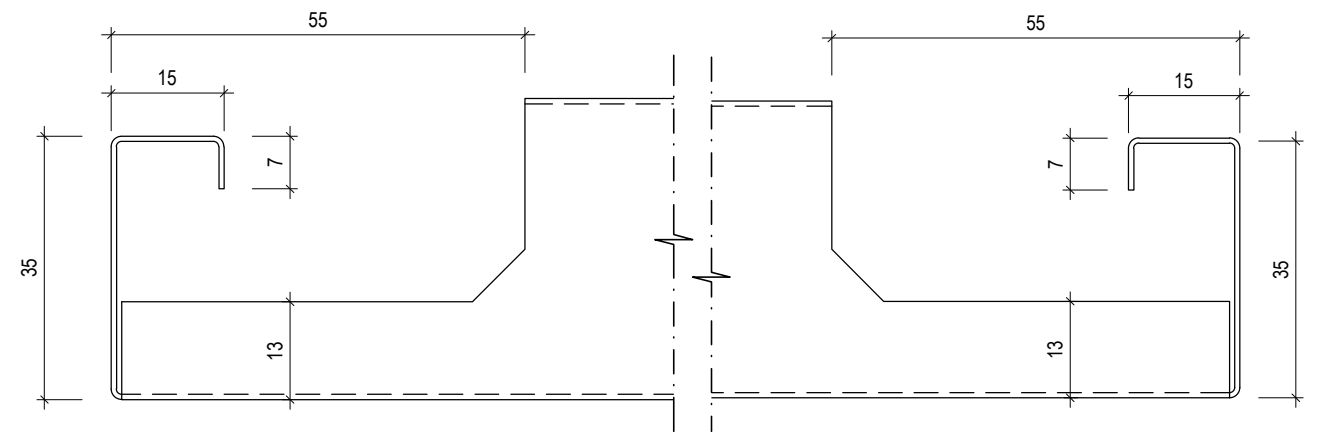

Z-PROFILE 40 Fe

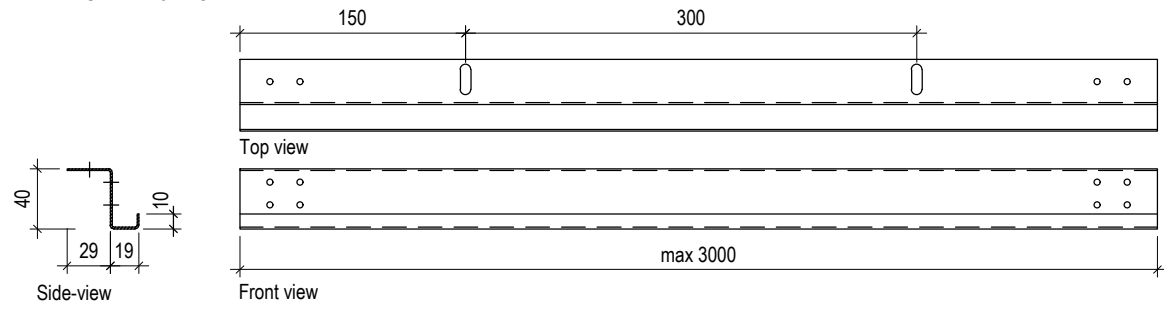

Z-PROFILE SPLICE 40

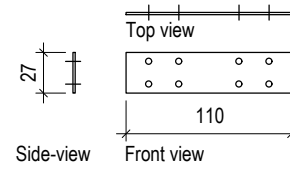

UPPER NONIUS HANGER
Length: 150, 300, 500, 1000, 1500, 2000mm

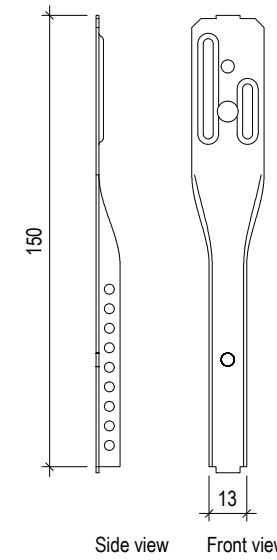

LOWER NONIUS HANGER

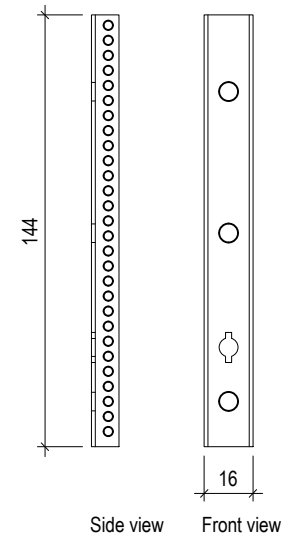

SAFETY LOOP PROFILE Fe

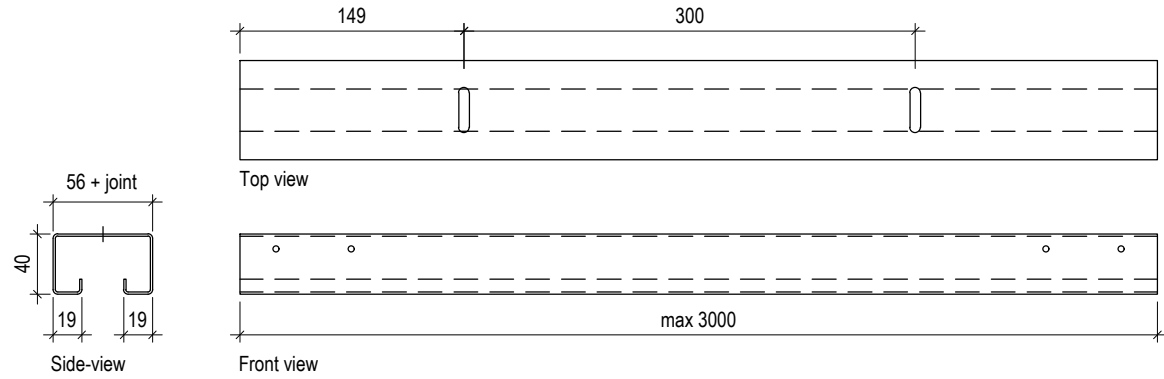

EDGE-PROFILE Al / Fe

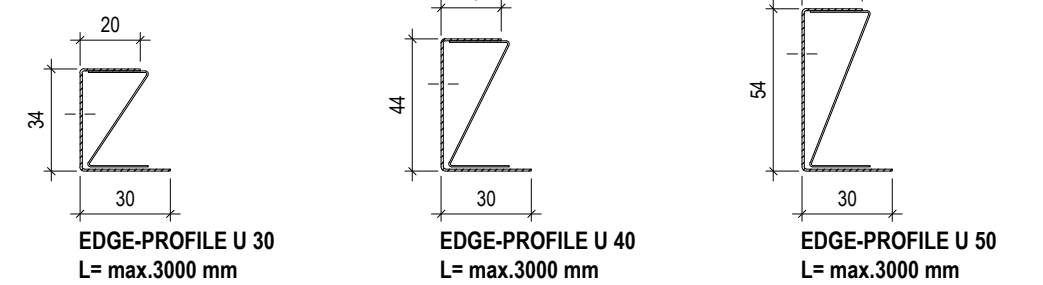

PRIMARY PROFILE 34.4525

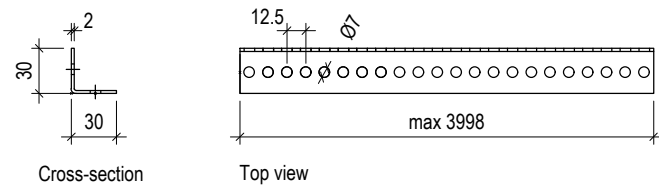

PRIMARY PROFILE SPLICE 34.4530

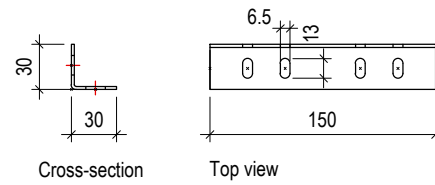

SPACER 3 mm

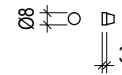

SAFETY LOOP SPLICE 66

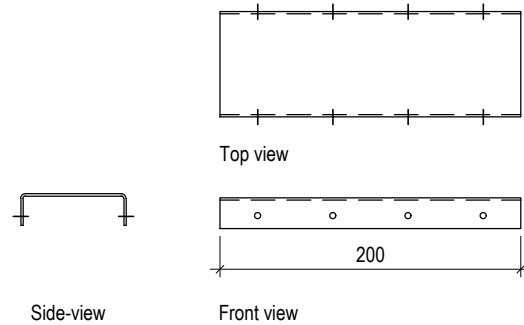

LOCKING PLATE 66 + screw

